

Elbow Installation (if supplied):

Step 1

- Wall lining hole should be cut or finished as per the dimension shown in the diagram on the right.
- Cut off the threaded nipple 15±2mm from the wall lining and apply thread seal tape to ensure a good seal.

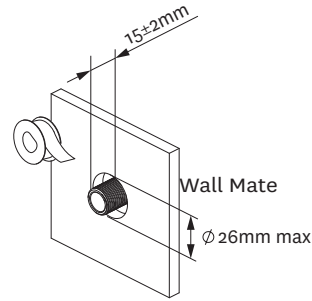

Step 2

- Screw the elbow onto the nipple ensuring that the o-ring is sufficiently compressed to create a watertight seal.
- Ensure that the elbow is oriented vertically with the outlet oriented downwards.

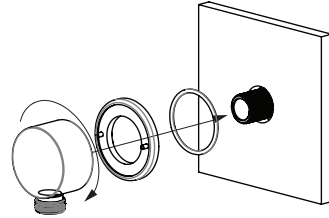

Care and Cleaning:

Never use abrasives or abrasive cleaning agents to clean this product. Clean regularly with contamination free warm soapy water and a damp soft cloth.

Periodically the filter washer should be removed from the end of the shower hose and cleaned.

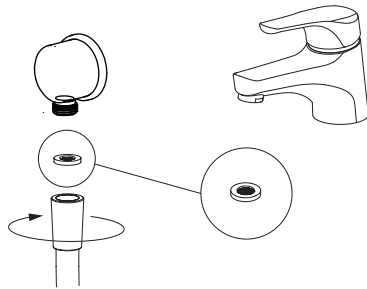

Methven warrants this product against manufacturing defects and that it is suitable for use under the general operating conditions specified in this instruction sheet. However, regional regulations apply and may affect your warranty. Please refer to www.methven.com or call customer service for full details.

New Zealand
0800 804 222

Australia
1300 638 483

UK
0800 195 1602

98-0338

ISSUE A
JAN 2016

ROUND BRASS RAIL Installation Guide

Technical Specifications:

Inlet Connections:

All 1/2" BSP

** Regional specific regulations apply.*

Please refer to your warranty statement at
www.methven.com

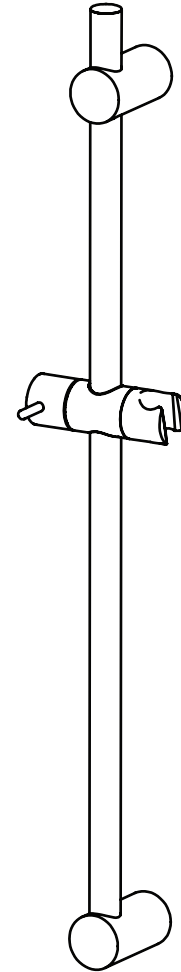

METHVEN
www.methven.com

IMPORTANT: Please read all of the instructions before installation.

General:

- This product must be installed in compliance with all relevant regional regulations.
- It is the responsibility of the installer to ensure a waterproof seal is achieved between the product and mounting surface. If in doubt about the quality of the seal, remove the product and reinstall using silicone to ensure a seal is achieved.
- All pipe work must be thoroughly flushed prior to the installation of the hose.
- After installation all connections must be checked for leaks.
- All outlets used primarily for personal hygiene shall deliver water at a safe temperature as per regional regulations.

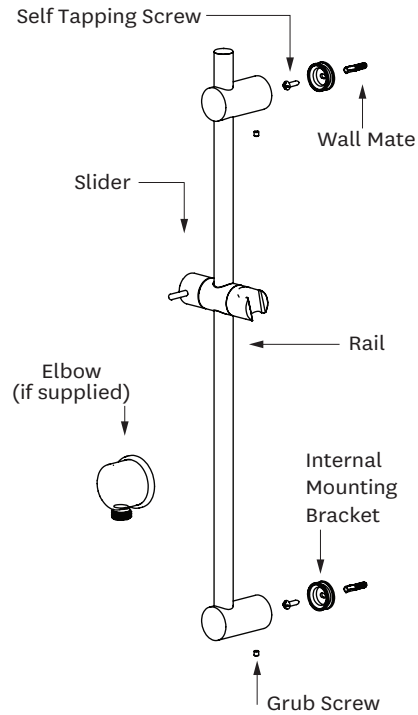

Step 2

- Match the mounting brackets to wall bosses and push into place.
- Slide the rail up or down to centralise the brackets.
- Remove the rail and tighten the tensioning screws firmly.
- Relocate the rail onto wall bosses and tighten grub screws top and bottom.

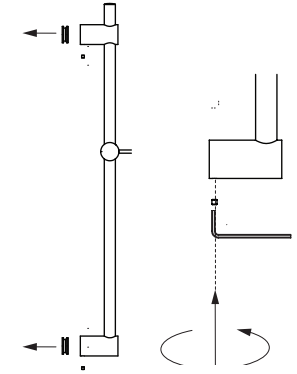

Step 3

- To adjust slider position, rotate the slider handle to unlock and lock the slider as shown.

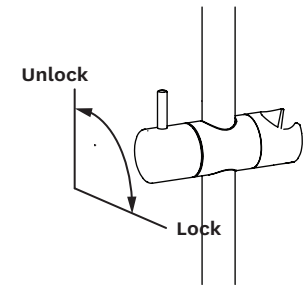

Step 1

- Mount the wall boss housings in desired position with the screws. Check the mounts are vertically aligned. Ensure the grub screws are located on the correct sides as shown.

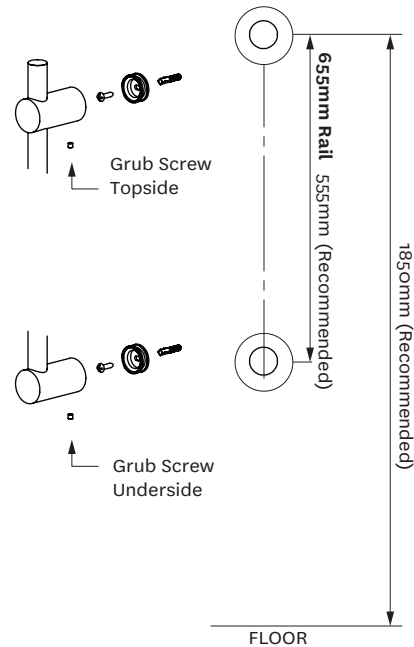

HANDSET

Installation Guide

Technical Specifications:

Operating Pressure:

Min: 150kPa/1.5bar

Max: 500kPa/5bar*

Operating Temperature:

Hot: Max 70°C*

Cold: Min 5°C

Inlet Connections:

½" BSP

** Regional specific regulations apply.*

Please refer to your warranty statement at

www.methven.com

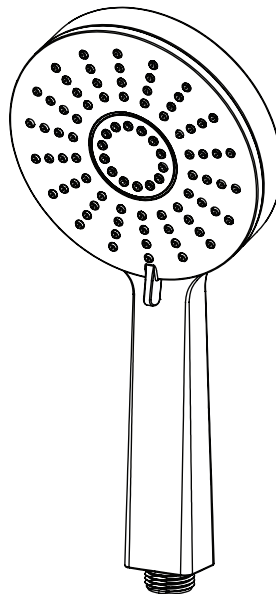
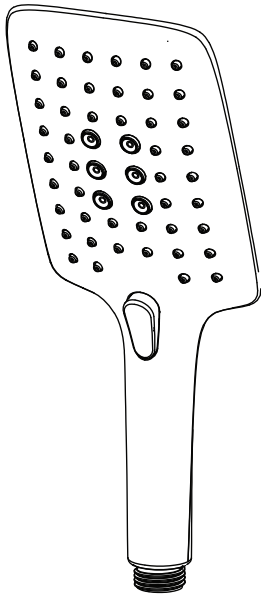

IMPORTANT: Please read all of the instructions before installation.

General:

- Methven recommends this product is installed by a licensed plumber in compliance with all relevant regional regulations.
- After installation all connections must be checked for leaks.
- All outlets used primarily for personal hygiene shall deliver water at a safe temperature as per regional regulations.
- It is the responsibility of the installer to ensure a waterproof seal is achieved.
- NOTE: Some showers may not provide an effective shower when used with gravity fed heated water systems or where pressures are less than 150kPa/1.5bar at the outlet. Additionally showers with flow rates of less than 9L/min may not allow the following to function correctly:
 - some instantaneous water heaters
 - some tempering valves
 - some thermostatic mixing valves

Step 1

- Connect hose to outlet bracket and handset.

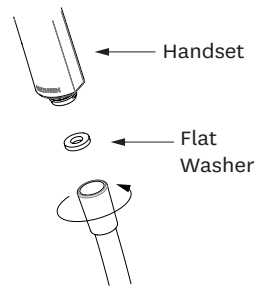

Care and Cleaning:

Never use abrasives or abrasive cleaning agents to clean this product. Clean regularly with contamination free warm soapy water and a damp soft cloth.

A filter washer should be installed in the hose cone on the water outlet and it should be cleaned periodically.

If shower performance is compromised by the build-up of lime-scale, soak in limescale remover for up to 10 minutes. Do not use products containing chlorine bleach or hydrochloric acid as these can damage the shower. Always rinse the shower thoroughly after cleaning to remove cleaning products that can damage the shower.

Never insert objects into the spray nozzles or attempt to remove limescale with sharp objects or abrasives.

Methven warrants this product against manufacturing defects and that it is suitable for use under the general operating conditions specified in this instruction sheet. However, regional regulations apply and may affect your warranty. Please refer to www.methven.com or call customer service for full details.

New Zealand
0800 804 222

Australia
1300 638 483

UK
0800 195 1602