

Soap Dish Holder

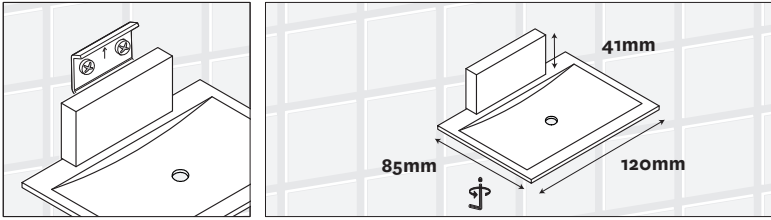

Bathroom Shelf

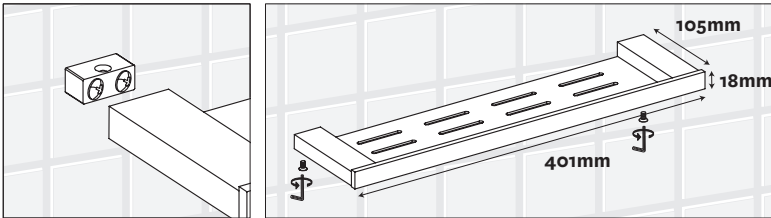

All Methven accessories are constructed from brass, and are able to hold up to 5 kilograms.*
 *(Bathroom Shelves are constructed from brass and stainless steel)

Care and Cleaning:

Never use abrasives or abrasive cleaning agents to clean this product. Clean regularly with contamination free warm soapy water and a damp soft cloth.

Methven warrants this product against manufacturing defects and that it is suitable for use under the general operating conditions specified in this instruction sheet. However, regional regulations apply and may affect your warranty. Please refer to www.methven.com or call customer service for full details.

New Zealand
 0800 804 222

Australia
 1300 638 483

UK
 0800 195 1602

SURFACE ACCESSORIES Installation Guide

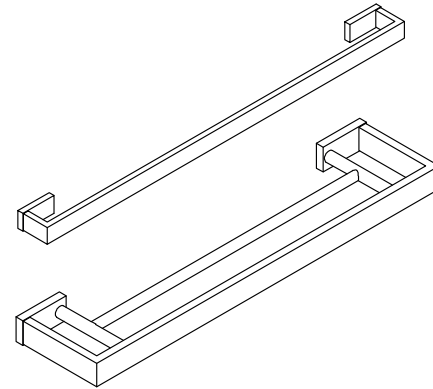

*Single and Double Towel Rails available in both 600mm and 900mm

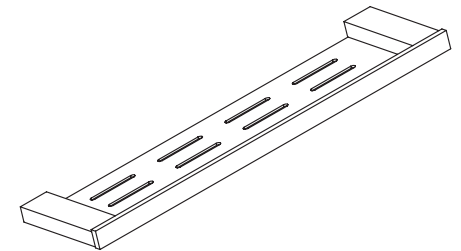
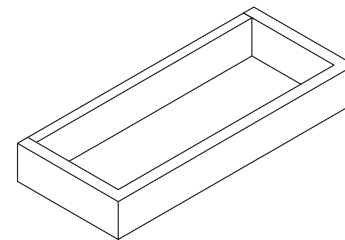
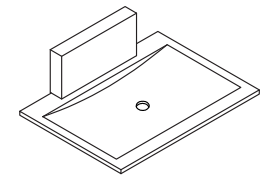
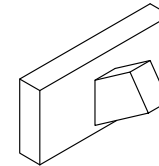
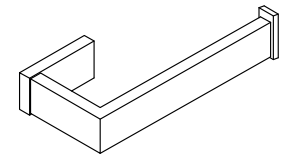

Please refer to your warranty statement at www.methven.com

IMPORTANT: Please read all of the instructions before installation.

Installation:

1. Measure and mark positions

Choose a position for your accessory. Measure the distance between the fixings on the base of the accessory and transfer these measurements onto the wall. Measure an equal distance down from the bottom of a tile and mark the measurements to make sure they are even and level.

2. Pre-drill the holes

Now drill into the marked measurements, right through the tiles into the wall.

3. Insert the wall plugs

Remove the tape and insert the wall plugs into your holes. If you need to, use a hammer to gently tap the plugs in.

4. Remove the plates from your accessory

Using the Allen key provided, remove the plates from your accessory.

5. Screw the plates to the wall

Using your drill, screw the plates into the wall plugs so that they are flush with the tiles.

6. Check the plates are level

With your tape measure, check that the distance from the plates to the edge of the tiles below them is the same. If not, then you will need to make adjustments. This will ensure your accessory will look straight once it is installed.

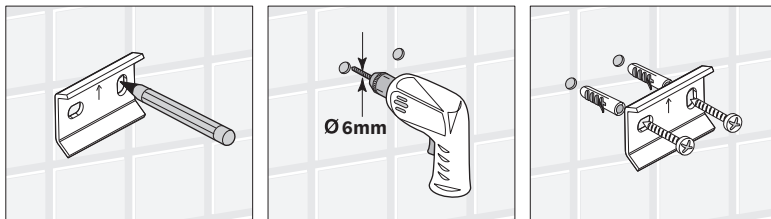

7. Attach the accessory to the wall

Finally, connect the accessory to the plates on the wall. Tighten it using the Allen key. Then check that the accessory is level.

8. Check the levels

Finally, check that the accessory is straight, using your spirit level. If not, then you will need to make some adjustments. Please refer to the following series of images for your corresponding accessory.

IMPORTANT NOTE:

Wall materials vary. The accessory fixing kit supplied is suited for solid wall fixing. For timber framed walls, please ensure the accessory is fixed to a noggin/stud behind the wall. Where stud/noggin is not available, please use suitable hollow wall fixing.

Single Towel Rail (600mm and 900mm)

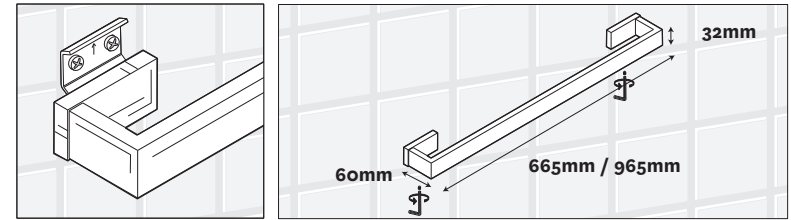

Double Towel Rail (600mm and 900mm)

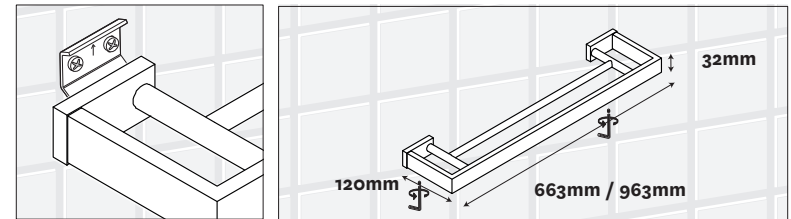

Robe Hook

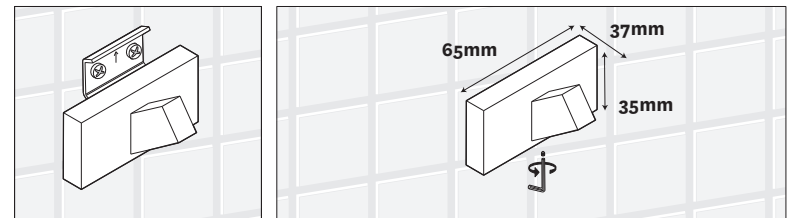

Towel Ring

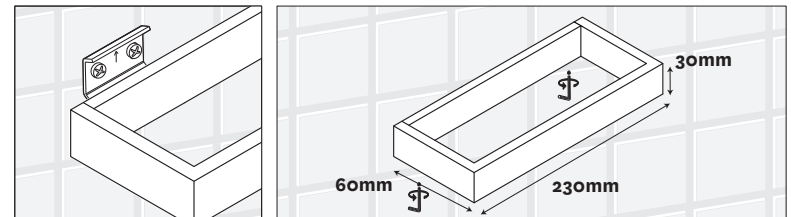

Toilet Roll Holder

