

Warranty Information

Proof of purchase will be required.

The guarantee does not cover faults or damage caused by incorrect installation and/or maintenance, ordinary wear and tear, water composition, etc.

*Please see www.deva-uk for full terms and conditions of warranty

Cleaning

Your product has a high-quality finish and should be treated with care to preserve the visible surfaces. Never use abrasives or abrasive cleaning agents to clean this product clean regularly with contamination free warm water and a damp soft cloth. Do not use products containing chlorine bleach or hydrochloric acid as these can damage the product.

We have a policy of continuous improvement and reserve the right to change specifications without notice.

METHVEN UK LIMITED
METHVEN EXPERIENCE CENTRE
3/3A STONE CROSS COURT
YEW TREE WAY
GOLBORNE
WARRINGTON
WA3 3JD
UNITED KINGDOM

TEL: 0800 195 1602
FAX: 0844 406 8690
EMAIL: sales@uk.methven.com
www.deva-uk.com
www.methven.com

INST-WAI3BSMBB, WAI3BSMBK,
WAI3BSMBN & WAI3BSMGM-V1
22.03.2021

Wai 3 Hole Deck Bath Shower Mixer

WAI3BSMBB, WAI3BSMBK, WAI3BSMBN & WAI3BSMGM Installation Guide

Technical Specification

Working Pressure:

Min: 0.3 Bar

Max: 5.0 Bar

Operating Temperature:

Hot: 65°C

Cold: 5°C





Inlet Connections:

3/4" BSP

Features:

- On trend finish for a designer look
- Contemporary square design
- Complete with Waipori Satinjet handset regulated to 8 l/minute
- Water efficient without compromising showering performance
- Ceramic disc handles ensure a smooth operation
- Products which are easy to use by all the family



-  Chrome
-  Matte Black
-  PVD Brushed Brass
-  PVD Gunmetal
-  PVD Brushed Nickel



METHVEN
www.methven.com EST 1886

Contents

Congratulations on your purchase of your new Methven Wai 3 Hole Deck Bath Shower Mixer Chrome. Our fitting instructions have been created with you in mind to provide you with all the information you require and, if you need any further help, please don't hesitate to contact our customer care team on 0800 195 1602.

General Safety Information 3

Line Drawing 3

Product Breakdown 4

Product Breakdown 4

Installation Requirements 6

Installation 6

Troubleshooting 7

Warranty Information 8

Cleaning 8

Troubleshooting

Symptom	Cause(s)	Resolution
No flow or low flow rate	Partially closed isolation valve	Open isolation valve
	Instantaneous water heater cycles on and off as flow rate or pressure is too low	Increase water flow rate or pressure through system.
	Air lock or partial blockage in the supply pipework or hoses	Flush through pipework to ensure removal of debris and any airlocks.
	Hot or cold water being drawn off elsewhere causing pressure changes or instantaneous boiler temperature changes.	Try not to use other water outlets when using the mixer
Water dripping from the mixer	This is normal for a short time after using the mixer	This is due to residual water tension, the build up of water in the tap body.
	If water continues to drip, possible issue with the flow control cartridge.	Please contact our customer care team.
Mixer does not turn on	Closed isolation valve	Open isolation valve
	Mains water supply turned off	Turn on mains water supply

Installation Requirements

Before commencing installation of the new product, ensure that the system has been flushed to remove any debris, which could cause damage to the valves and invalidate the warranty.

Installation

Drill three holes on the bath if required.

Install the Spout

1. Remove the tee connector (31), nut (34), Fixing Kit (11,12 & 13) from spout tail.
2. Then place the spout inlet connector (23) through the second from left bath hole with the base plate (8) under spout.
3. Slide the Fixing Kit (11,12 & 13) over the inlet connector (23) and tighten with screw driver.

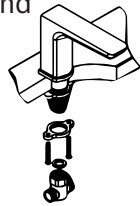

Install hot/cold control valve

4. Fitting the Hot/Cold Control Valve on the left of the spout.
5. Remove Fixing Kit, (10,11,12 & 13) from Valve Body (7).
6. Place the Valve Body (7) through the 1st hole in the bath.
7. Slide the Fixing kit over its tail and tighten with screw driver. Hole 1 should now be installed as per image

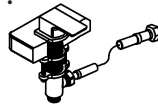

9. Connect Flexi Tails (14 & 15) to the underneath of valve body (7)
10. Connect the tee connector and the hot/cold control valves using braided hoses.

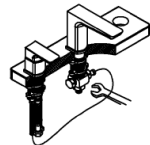

11. Put the tail for the handset holder through the 3rd hole, tighten with the backnut.
12. Adjust all parts in their position and then tighten all connections.
13. Connect the shower hose from the connection under the spout through the handset holder in hole 4.
14. Connect the handset to the Shower hose.
15. Connect water supplies and the hot/cold control valve. Check for any leaks.

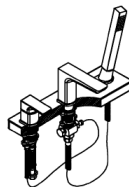

Please keep these instructions for future reference and request of replacement parts

General Safety Information

Please read all of the instructions before installation.

Methven recommends this product is installed by a competent person in compliance with all relevant regional regulations.

Remove all packaging and check the components for damage before starting installation.

This product **must** not be modified in any way as this will invalidate the guarantee. It is the responsibility of the installer to ensure a waterproof seal is achieved, after installation all connections must be checked for leaks. All outlets used primarily for personal hygiene shall deliver water at a safe temperature as per regional regulations.

Line Drawing

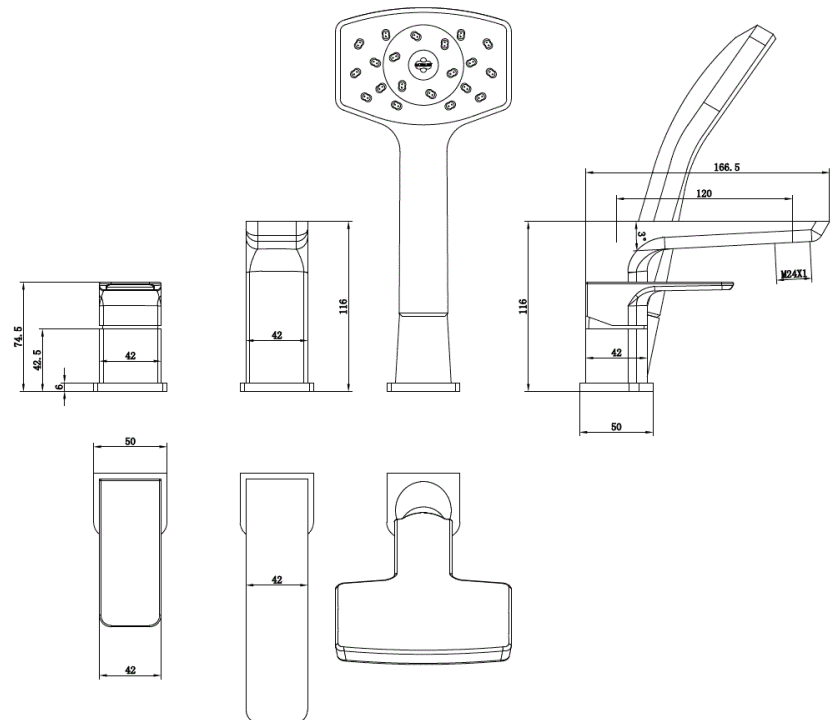

Product Breakdown

Check All components are present prior to starting installation.

Item	Description
1	Indice
2	Pointed Screw
3	Handle
4	Cartridge Cover
5	Cartridge nut
6	Cartridge
7	Body
8	Base Plate
9	Washer
10	Washer
11	Fixing Part
12	Fixing Nut
13	Cross Screw
14	Flexi Tail
15	Flexi Tail
16	Washer
17	Nut
18	Connector
19	Flat Screw
20	Spout
21	Flat Screw
22	O-Ring
23	Inlet Pipe
24	Spring
25	O-Ring
26	Divertor Stem
27	O-Ring
28	Divertor Stem
29	Brass Ring
30	O-Ring
31	4 Way Valve Body
32	O-Ring
33	Outlet Connector
34	Fixing nut
35	Fixing Nut
36	Washer
37	Shower Hose
38	3/4 Inlet
39	Shower Holder
40	Handshower
41	Nozzle

